

Installation Guide

Ancon Non-Drill Range

The Product Range

The Ancon Non-Drill range of fixings joins masonry to structural steelwork without shot-firing or drilling. They restrain walls against lateral wind loads. The range comprises:

- **Internal Column Tie (Standard and Bespoke Sizes)**
- **Briclok Tie**
- **Hammer-On Column Tie**
- **Hammer-On IHR-H Head Restraint**

Standard Internal Column Tie Application

- Plan View

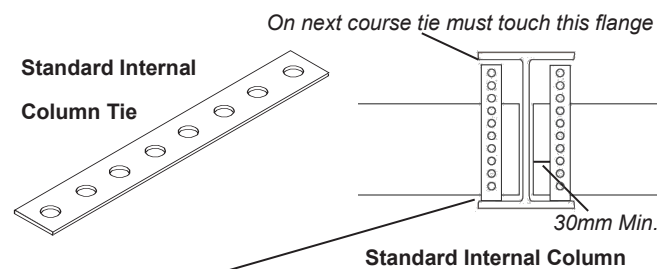

The tie must be in contact with one flange; the choice of flange should alternate at each course

Avoiding Bi-Metallic Corrosion

Bi-metallic corrosion may occur in a damp environment where stainless steel fixings are in contact with a structural steel frame. This will not affect the stainless steel but may cause slight surface corrosion to the mild steel. Best practice is to isolate the two dissimilar metals. Bitumen paint or some other form of isolation e.g. adhesive tape, applied at the point of contact will prevent this corrosion.

Safety Precautions

Ancon products are produced from stainless steel plate, coil and wire. As with all such construction products, these may present sharp edges. **Suitable personal protective equipment should be worn at all times during handling and installation.**

Internal Column Tie

The internal column tie fits between the flanges of popular UB and UC steel sections. A series of holes provides the necessary anchorage to the blockwork.

The tie is available in seven standard lengths to suit the steel sections shown in the table. The ties are positioned just inside the column flanges at every joint and embedded in the mortar. Blockwork should extend as far as possible towards the web of the column so that there is at least 30mm of blockwork beyond the tie.

When not a snug fit against both flanges, these ties must be in contact with one column flange; the choice of flange should alternate at each course.

Non-standard variations of this product are designed for use where the blockwork is situated outside the column flange.

Standard Lengths	Beam/Column Sizes
179 mm	203 x 203 UC
186 mm	203 x 133 UB
224 mm	254 x 254 UC
232 mm	254 x 146 UB
275 mm	305 x 305 UC
281 mm	305 x 127 & 165 UB
330 mm	356 x 127 & 171 UB

Example Bespoke Internal Column Tie

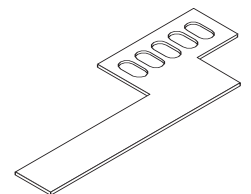

Application - Plan View

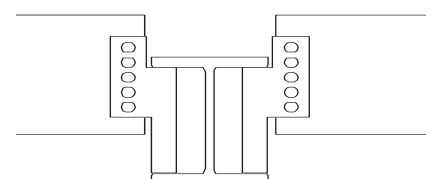

Briclok Ties

Briclok fits to a column flange and can be used either across a cavity or back into the inner leaf. It is available in two types and two lengths, see table for full details.

Select the correct slot size on the Briclok tie. The slot size should be as near as possible to the flange size on the column but allow the flange to pass the 10mm guide mark clearly shown on the Briclok ties. The Briclok tie should be positioned by hand and be a loose fit on the column flange. It must not be forced onto the flange in any way. The other end of the Briclok tie should be fully embedded into the bed joint to a minimum depth of 60mm.

When installed into the inner leaf, there must be a minimum of 25mm between the external leaf and the nearest edge of a Briclok. Ensure adequate drainage and ventilation in the cavity at each column location and remove any mortar droppings from the ties.

Product Code	Length	Open Cavity *	Flange Thickness
Briclok150A	150 mm	20-50 mm	6.8-13.5 mm
Briclok180A	180 mm	50-80 mm	6.8-13.5 mm
Briclok150B	150 mm	20-50 mm	13.5-20.0 mm
Briclok180B	180 mm	50-80 mm	13.5-20.0 mm

* Open cavity at column face

Briclok Type A

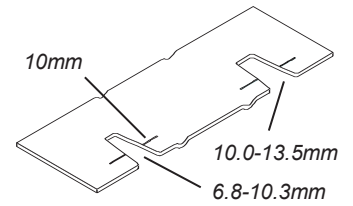

Briclok Type B

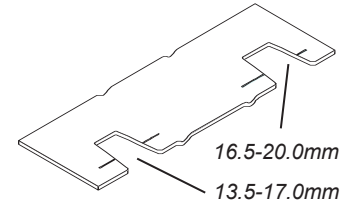

Briclok Application - Plan View

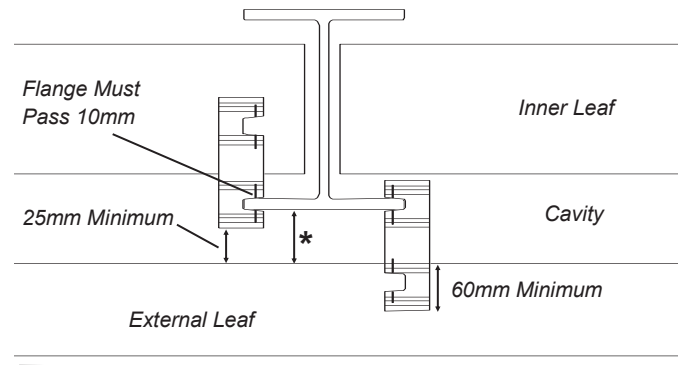

Hammer-On Section

Available in five sizes to accommodate a steel thickness from 6.8mm to 25mm, this fixing is simply hammered onto the flange. It is utilised either on a column with a tie or on a beam with an internal head restraint.

The Hammer-On Section resists load in one direction only and must be installed on alternate sides of the flange. Ties should be installed at 225mm vertical centres and head restraints at 450mm horizontal centres.

Hammer-On Section

Hammer-On Section Ref.	Flange Thickness Accommodated
HOS-XS (+ length)	6.8-10 mm
HOS-S (+ length)	10-13 mm
HOS-M (+ length)	14-17 mm
HOS-L (+ length)	18-21 mm
HOS-XL (+ length)	22-25 mm

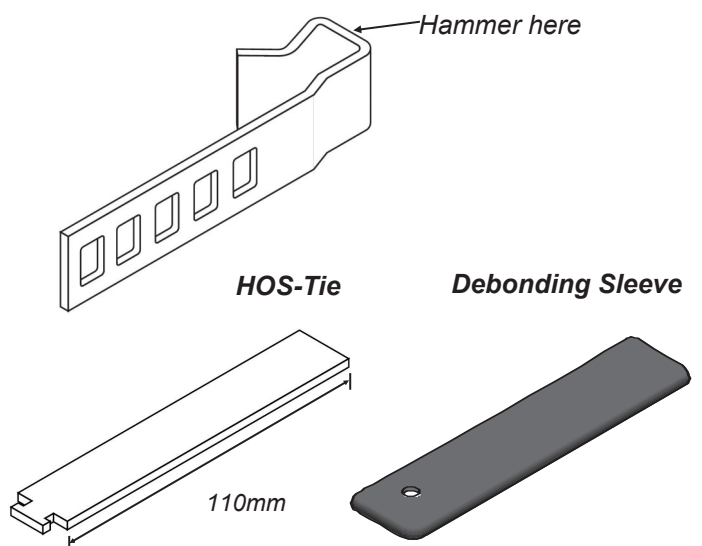

Hammer-On Column Tie

The hammer-on column tie is a two-part wall tie used for transferring horizontal shear from the end of a wall into the flange of a steel column.

The appropriately sized Hammer-On Section is placed on the column flange at the correct height with the longer side to the outside of the column. The flat return is then hammered onto the flange until the inside of the return is in contact with the edge of the column flange.

The notched end of the tie is located in one of the five rectangular slots so that its position is central within the blockwork, or at least 40mm from the edge of the block. A plastic debonding sleeve should be fitted to the tie which should be surrounded by mortar, before the next block is placed on top.

The procedure will be repeated at each block course. **Important: The Hammer-On Section must be fixed to alternate sides of the flange.**

Hammer-On IHR-H Head Restraint

IHR Head Restraints provide the necessary restraint at the top of masonry walls. The tongue section, fixed at the top, slides inside the lower channel section to allow vertical movement to take place between the wall and the structural frame.

The standard IHR is designed to suit a 215mm high block, however bespoke channel lengths are available. The sliding top section is available in two lengths to accommodate gaps of 25-50mm and 51-75mm.

IHRs should ideally be positioned centrally in the width of the wall, where this is not possible the centre of the stem should be at least 50mm from the edge of the wall. The horizontal leg of the lower section which is approximately 6mm thick, should be placed directly on top of the block below. Both the bed joint and each side of the stem in the vertical joint should be filled with mortar.

The appropriately sized Hammer-On Section is placed on the steel flange at the correct position with the longer side to the underneath. The flat return is then hammered until the inside of the return is in contact with the edge of the flange. Fix at 450mm centres.

Important: The Hammer-On Section must be fixed to alternate sides of the beam.

The Construction applications and details provided in this guide are indicative only. In every case installation should be entrusted to appropriately qualified and experienced persons. Normal handling precautions should be taken to avoid physical injury. The company cannot be held responsible for any injury as a result of using our products, unless such injury arises as a result of our negligence.

© Protected by copyright

Hammer-On Column Tie — Components

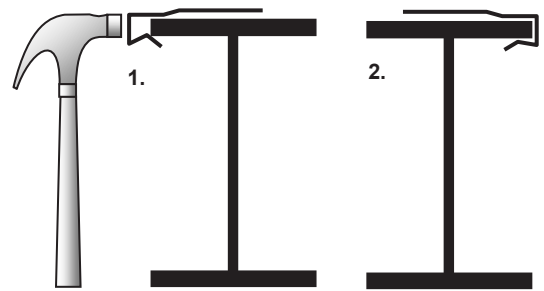

Plan View Application - The Hammer-On Section MUST be fixed to alternate sides of the flange (225mm Vertical Centres) as work progresses

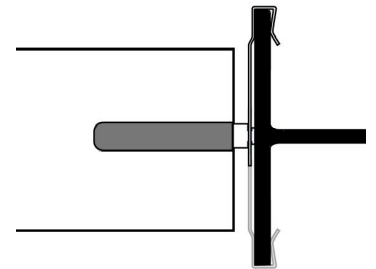

Hammer-On IHR-H — Components

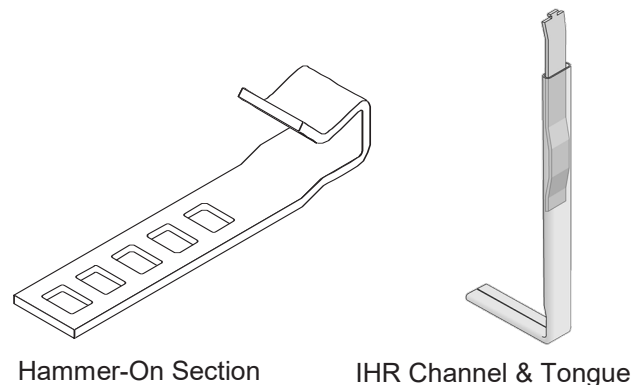

IHR-H Application—Vertical Section View—The Hammer-On MUST be fixed to alternate sides of the flange (450mm horizontal centres)

